

MEDGUARD®

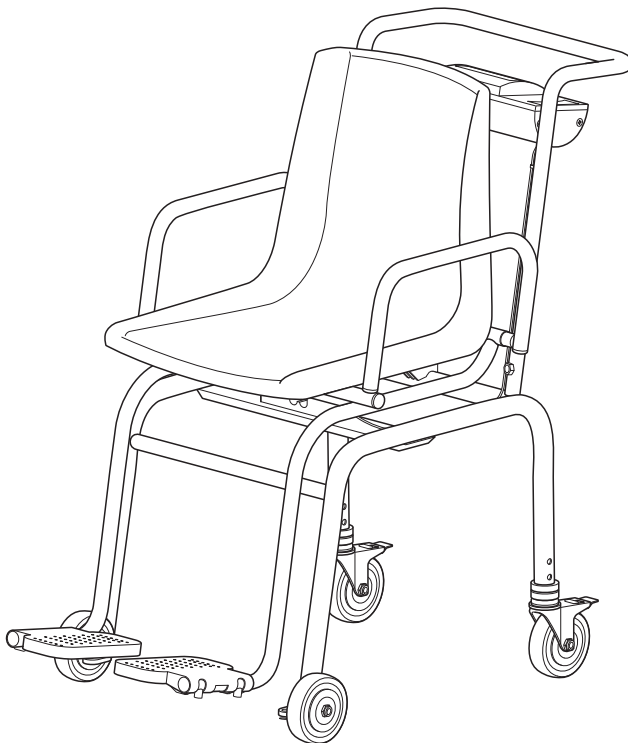

Professional Healthcare Supplies

seca 955



GB **Instruction manual and guarantee**

Medguard Professional Healthcare

Tel: +353 (0) 1 835 2411

Email: sales@medguard.ie

Fax: 01 969 5009

Website: www.medguard.ie

Unit 6/7, Block 4, Ashbourne Business Park, Ashbourne, Co. Meath, A84 VK52

CONTENTS

1. Full certification	4	6.3 Additional functions (menu) . . .	22
2. Description of device	5	Navigate in the menu.	22
2.1 Congratulations!	5	Clear stored values	
2.2 Intended use	5	automatically (ACLR).	23
3. Safety information	6	Permanently store additional	
3.1 Basic safety precautions	6	weight (Pt)	23
3.2 Safety information in this		Activate Autohold function	
manual	7	(AHOLd)	24
Handling the instrument.	6	Activate acoustic signals	
Use of measured results	7	(bBEEP)	25
3.3 Handling (rechargeable)		Select attenuation (FIL)	25
batteries	8	Restore factory settings	
4. Overview	9	(rESET)	26
4.1 Controls/Features	9	7. Cleaning	26
4.2 Symbols in display.	10	8. What to do if ...?	27
4.3 Information on rating plate.	11	9. Maintenance/Verification	28
4.4 Menu structure	12	9.1 Information about	
5. Before you get started	13	maintenance and verification	28
5.1 Scope of delivery, assembled	13	9.2 Check content of verification	
5.2 Establishing the power supply	14	counter	28
Insert the rechargeable battery		10. Technical data	29
block	14	11. Spare parts	30
Connect the power supply unit	15	12. Disposal	30
6. Operation	16	12.1 Disposal of device.	30
6.1 Aligning the scale	16	12.2 Batteries (including	
6.2 Weighing.	17	rechargeables).	30
Switching on the scale.	17	13. Warranty	31
Start weighing	18	14. Declaration of Conformity	31
Tare off additional weight			
(TARE)	19		
Continuous display of measured			
result (HOLD)	19		
Determine and evaluate body			
mass index (BMI)	20		
Automatic switchover of			
weighing range	21		
Switch off scales	21		

1. FULL CERTIFICATION



With products from seca you are not only purchasing technology developed over a century, but also quality that has been validated by official bodies, the legal system and relevant institutes. seca products comply with European directives, standards and national laws. With seca you are buying into the future.



Scales bearing this symbol comply with the stringent requirements of Class III of the directive 2014/31/EU and can be used for medical measurements which are subject to calibration.



Device complies with EC standards and directives.

- **M:** Conformity label according to Directive 2014/31/EU governing non-automatic weighing instruments (verified models)
- **18:** (Example: 2018) Year in which the declaration of conformity was completed and the CE symbol was applied (verified model)
- **0102:** Notified body metrology (verified models)
- **0123:** Notified body medical product

seca's professionalism is also recognized by official testing agencies. TÜV Süd Product Service, the agency responsible for medical products, confirms with this certificate that seca adheres consistently to the strict legal requirements as a medical product manufacturer. seca's quality assurance system includes the areas of design, development, production, sales, and service of medical scales and height measurement systems as well as software and measurement systems for the assessment of the state of health and nutrition.

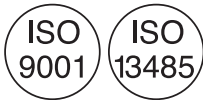

seca contributes to environmental protection. We are anxious to preserve our natural resources. This is why we strive to save packaging material where practical. And what is left over can be conveniently disposed of locally via Germany's Dual System recycling programme.



2. DESCRIPTION OF DEVICE

2.1 Congratulations!

With the **seca 955** electronic scale, you have just purchased a highly precise and simultaneously robust weighing instrument.

seca has put its experience at the service of health care for over 170 years and as a market leader in many countries, is constantly setting new standards with its innovative developments for weighing and measurement.

2.2 Intended use

The **seca 955** electronic scale is mainly used at hospitals, medical practices and inpatient care facilities in accordance with national regulations.

The scale is for conventional determination of weight and establishment of general state of nutrition; it assists the physician supervising treatment in making a diagnosis or deciding on a course of treatment.

To make an accurate diagnosis, however, other specific examinations have to be ordered by the physician and their results taken into account in addition to determining a weight value.

Besides conventional weight measurement the **seca 955** also features a function to calculate the body mass index. The keypad is used to enter the height, and this is followed by automatic calculation of the body mass index from the weighing value.

The **seca 955** is provided with rollers to allow it to be moved about and thanks to its low power consumption, it will offer hours of battery operation for mobile applications.

The **seca 955** is **not** intended for the transport of people or objects. Use the scale only for the purpose named in this section.

3. SAFETY INFORMATION

3.1 Basic safety precautions

Handling the instrument

- Please take note of the information in this user manual.
- Keep the user manual with the declaration of conformity in a safe place.
- Make sure that the scales are positioned securely on a flat and stable surface.
- Make sure before each use that the wheel brakes are working.
- Secure the scale against unintentional rolling away. Set the wheel brakes.
- Do not transport any people or objects with the scale.
- Move the scale only with released wheel brakes.
- Make sure you do not drop the scales. Protect the scales from violent impacts.
- If you operate the scale with a battery power pack, make sure that when you route the power cable, no one can trip over it.
- If you operate the scale with a battery power pack, make sure that when you route the power cable, it cannot be crushed or come into contact with hot objects.
- Have the scales serviced regularly (see “Maintenance/Verification” on page 28).
- Make sure that maintenance and repair are only carried out by an authorised service partner. You can find your local service partner at www.seca.com or just send an e-mail to service@seca.com.
- Make sure you only use genuine seca accessories and spare parts. Otherwise the warranty provided by seca will become null and void.
- Make sure RF equipment such as mobile phones is kept at a minimum distance of approx. 1 metre to prevent incorrect measurements or interference with radio transmission.

Use of measured results

- Before you save and re-use values measured with the **seca 955** (e.g. in the **seca analytics 105** PC software or in a hospital information system), make sure that the measured values are plausible and that they correspond to the display on the measuring instrument.

3.2 Safety information in this manual

**DANGER!**

Used to identify an extremely hazardous situation. If you fail to take note of this information, serious irreversible or fatal injuries will result.

**WARNING!**

Used to identify an extremely hazardous situation. If you fail to take note of this information, serious irreversible or fatal injuries may result.

**CAUTION!**

Used to identify a hazardous situation. If you fail to take note of this information, minor to moderate injuries may result.

ATTENTION!

Used to identify possible incorrect usage of device. If you fail to take note of this information, you may damage the device or the measured results may be incorrect.

NOTE:

Includes additional information about use of the device.

3.3 Handling (rechargeable) batteries

This instrument is delivered with a rechargeable battery block. Heed the following safety instructions.



WARNING!

Personal injury with improper handling

Batteries contain harmful substances which may explode if not handled properly.

- Do not try to recharge such batteries.
- Do not expose (rechargeable) batteries to heat.
- Do not burn (rechargeable) batteries.
- If acid is leaking out, avoid contact with the skin, eyes and mucous membranes. Rinse affected areas with plenty of clean water and seek medical help at once.

ATTENTION!





Damage to device and malfunctions with improper handling

- Only use the type of (rechargeable) battery specified (see "Insert the rechargeable battery block" on page 14).
- When replacing (rechargeable) batteries, always replace a complete set at a time.
- Do not short-circuit (rechargeable) batteries.
- If you do not use the device for a long period of time, remove the batteries (incl. rechargeables). This will prevent acid from leaking into the device.

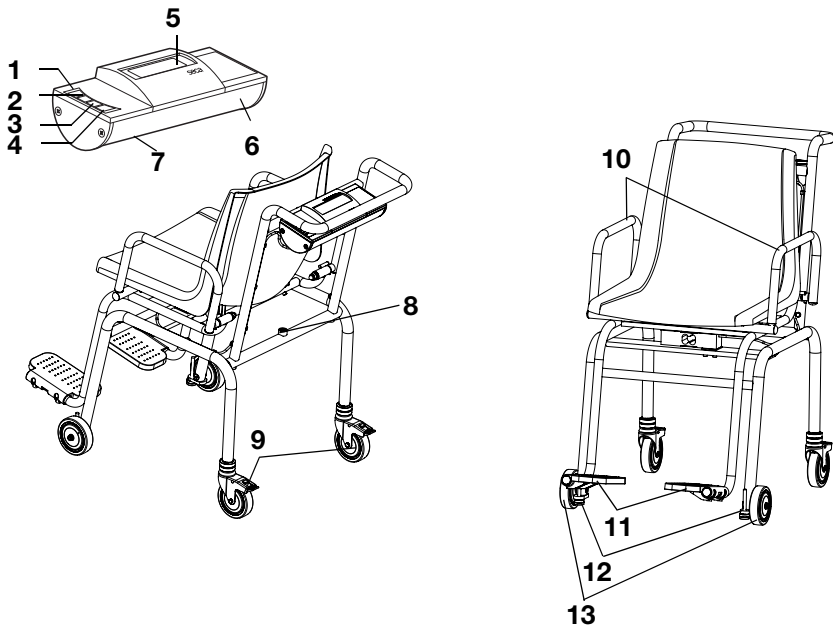
4. OVERVIEW

4.1 Controls/Features



No.	Control/Feature	Function
1		To switch scales off and on
2		Arrow key <ul style="list-style-type: none"> • While weighing: <ul style="list-style-type: none"> - Short press: Activate hold function - Long press: Activate tare function • On the menu: <ul style="list-style-type: none"> - Select submenu, select menu element - Increase value
3		Arrow key <ul style="list-style-type: none"> • During weighing: <ul style="list-style-type: none"> - Press briefly: Activate BMI function - Hold down: Call up menu • In menu: <ul style="list-style-type: none"> - Select submenu, select menu item - Reduce value
4		Enter key <ul style="list-style-type: none"> - Confirm selected menu element - Save set value









No.	Control/Feature	Function
5	Display	Display element for measured results and for device configuration
6	Battery compartment	Accommodation for the rechargeable battery block
7	Power pack connection	Serves to connect the included power pack
8	Spirit level	Indicates whether device is horizontal
9	Transport rollers	<ul style="list-style-type: none"> • Steerable • Height adjustable • With wheel brakes The scale can be moved on these rollers. The scale can be aligned precisely with these rollers.
10	Armrests	Swivel, so that it is easier for the patient to sit down
11	Footrests	<ul style="list-style-type: none"> • Swivel For correct measurement, the patient's feet must be on the footrests
12	Foot screw	2 screws, for precise alignment of device
13	Transport rollers	The scales can be moved about with these rollers

4.2 Symbols in display



	Symbol	Meaning
A		Rechargeable battery block is weak
B		Operation with power supply unit
C		Non-calibratable function active
D		Currently-used weighing range (see "Technical data" on page 29)

4.3 Information on rating plate

Text/Symbol	Meaning
	Name and address of manufacturer, date of manufacture
	Model number
	Serial number, consecutive
GAL	Value in m/s^2 (verified models) <ul style="list-style-type: none"> • Gravitational acceleration on earth • Depends on the intended location
ProdID	Product identification number, consecutive
Approval Type	Type designation of design approval
	Refer to user manual
	Type B electromedical device
	Device complies with EU standards and directives
	Only operate device with DC. Note the polarity of the device plug.
	Do not discard with household waste

4.4 Menu structure

Other functions are available in the menu of the device. This enables you to configure the device perfectly to suit the conditions in which you use it (details from page 22).

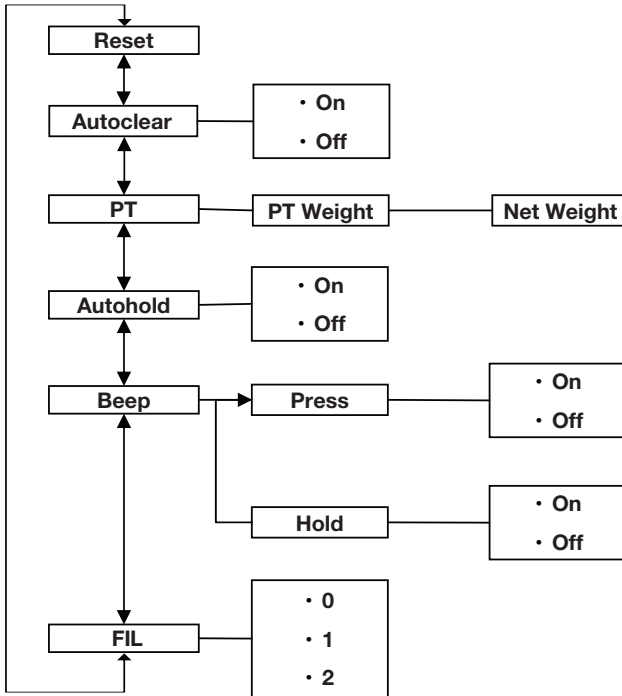

Call up menu:



Navigation:

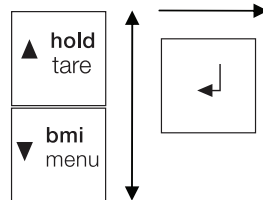

5. BEFORE YOU GET STARTED ...

5.1 Scope of delivery, assembled

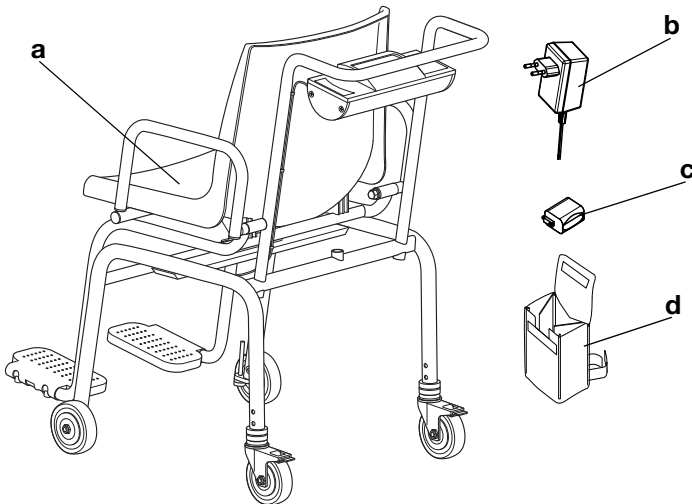

No.	Components	Pcs.
a	Scale	1
b	Power pack	1
c	Rechargeable battery block	1
d	Power pack carrier pouch seca 471	1
	Instructions for use, not shown	1

5.2 Establishing the power supply

Power is supplied to the scale with a rechargeable battery block or a power pack (both included in the scope of delivery).

Insert the rechargeable battery block

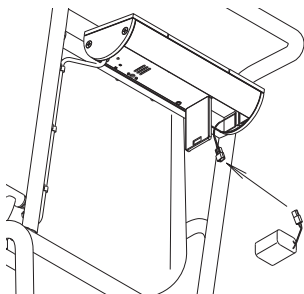

1. Press on latch of battery compartment.
2. Move down lid of battery compartment.
3. Remove the connector cable from the battery compartment.
4. Connect the connector cable to the rechargeable battery block.
5. Insert the rechargeable battery block into the battery compartment.
6. Close the battery compartment.

Connect the power supply unit

The rechargeable battery compartment is charged with the included power pack.



WARNING!

Personal injury and damage to device if incorrect power supply unit is used

The voltage provided by standard power supply units may be higher than their indicated rating. This may cause the scales to overheat, catch fire, melt or short-circuit.

- Only use genuine seca plug-in power supply units with 9 V or a controlled 12 V output voltage.

1. Insert the power plug necessary for your power supply unit in the power supply unit.
2. Insert the connector plug of the power supply unit in the connecting socket of the scales.
3. Plug the power supply unit into a mains socket.
4. Allow the scale to charge on the network for at least 24 hours when it is first charged so that the rechargeable battery block is completely charged.

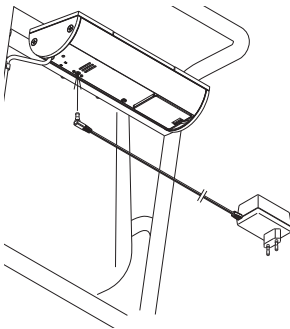

6. OPERATION

6.1 Aligning the scale

1. Place the scale on firm and even ground.
2. Align the scale.
 - With the foot screws on the front transport rollers
 - With the knurled head screws on the rear transport rollers

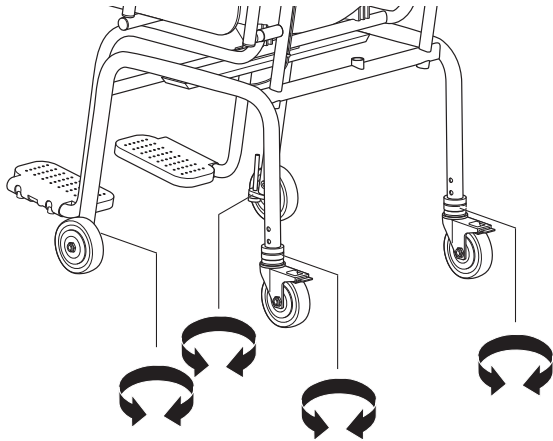

The air bubble in the spirit level must be located in the center of the circle.

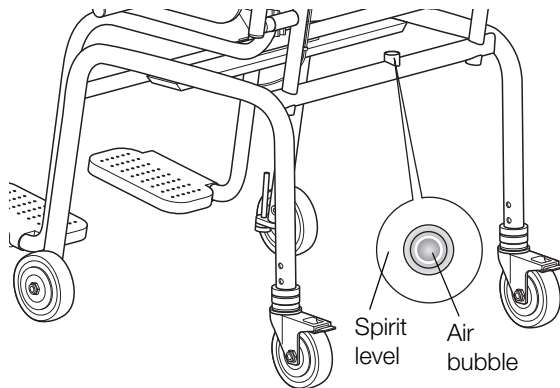

6.2 Weighing



CAUTION!

Patients can be injured if they fall

People with limited mobility can fall if they try to sit down on the scale.

- Make sure that the scale's wheel brakes are set.
- Assist people with limited mobility when they are sitting down.
- Leave the footrests folded up and pushed in until the patient is sitting on the scale.



CAUTION!

Patients can be injured if their limbs get pinched

The patient's hands and arms can be pinched between the seat and the lower frame or between the seat and the armrests.

- Make sure that the patient's hands and arms are on the armrests or in his lap during the weighing process.

ATTENTION!

Incorrect measurement due to force shunts

If accessories (e.g. the power pack pouch) or articles of clothing get caught between the seat and the frame, the weight will not be measured correctly.

If the patient's feet are not on the footrests, the weight will not be measured correctly.

- Make sure that there are no accessories or articles of clothing between the seat and frame.
- Make sure that the armrests are folded down during the weighing process.
- Make sure that the patient's feet are on the footrests during the weighing process.

Switching on the scale

- ▶ Press the Start key.

The display will read **SECR** and then quickly run through all elements of the display.

The scales are ready for operation when the display reads **0.00**.

If the device is being operated with a power supply unit, the symbol  will appear in the display.

Start weighing

1. Set the wheel brakes of the rear transport rollers.

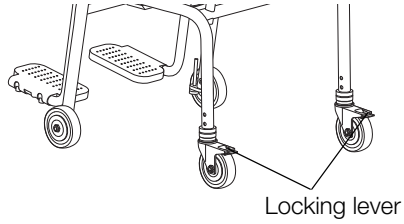

2. Fold the armrest toward the back in order to make it easier for the patient to sit down.

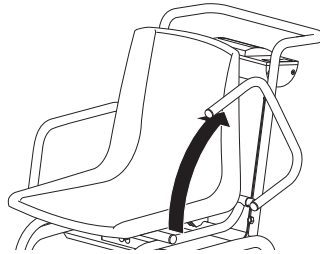

3. Make sure that the scale has no load.
4. Switch the scale on.
5. Ask the patient to sit down on the scale.
6. Fold the footrests down.

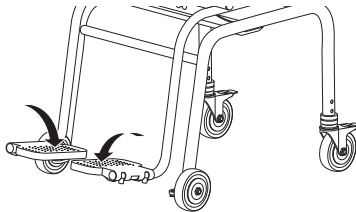

7. Ask the patient to put his feet on the footrests.
8. Fold the armrests down.
9. Read the measurement result.



Tare off additional weight (TARE)

You can use the TARE function to prevent the weighing result from being affected by an additional weight (e.g. a towel or pad on the weighing surface).

ATTENTION!

Incorrect measurement with force shunt

If an additional weight (e.g. large towel) is in contact with the surface on which the scales are standing, the weight will not be measured correctly.

- Make sure that any additional weight is only placed on the weighing surface of the scales.



1. Switch the scale on.
2. Place the additional weight on the scales.
3. Hold down the arrow key (**hold/tare**) until “NET” appears in the display.
4. Wait until the display stops flashing and is replaced by **0.00**.
5. Weigh the patient as described in section “Start weighing”.
6. Read off the measured result.
The additional weight has been automatically deducted.
7. To disable the TARE function, press the arrow key (**hold/tare**) until “NET” no longer appears in the display or switch off the scales.

NOTE:

The maximum weight that can be displayed is reduced by the weight of the objects already placed on the scales.

Continuous display of measured result (HOLD)

If you activate the HOLD function, the weighing value will continue to be displayed after the load has been removed. This allows you to attend to the patient before noting down the weight.



1. Check that there is no load on the scales.
2. Switch the scale on.
3. Weigh the patient as described in section “Start weighing”.
4. Briefly press the arrow key (**hold/tare**).



The display will flash until a stable weight is measured. The weighing value will then be displayed continuously. The \triangle symbol (non-calibratable function) and the message “HOLD” will be displayed.

5. To disable the HOLD function, briefly press the arrow key (**hold/tare**).

The \triangle symbol and the message “HOLD” will no longer be displayed.

NOTE:

If the auto hold function is activated, the weight value is displayed permanently automatically until the scale switches itself off or is switched off (see “Activate Autohold function (AHOLD)” on page 24).

Determine and evaluate body mass index (BMI)

The body mass index compares height and weight, so resulting in more accurate figures than with Broca's formula for ideal weight. It includes a tolerance range which is considered ideal in health terms.



1. Check that there is no load on the scales.
2. Switch the scale on.
3. Briefly press the arrow key (**bmi/menu**).
The message “BMI” appears.
Arrows can be seen flashing in the display.
The height last entered is displayed.
4. You can either accept this height or select another value using the arrow keys.
5. Confirm your selection with the Enter key.
6. Weigh the patient as described in section “Start weighing”.
7. Read off the BMI and compare it with the categories given below.
8. To disable the BMI function, briefly press the Enter key.

BMI	Evaluation
Under 18.5	The patient is underweight. There might be a tendency to anorexia. It is advisable that the patient puts on weight to improve well-being and performance. If in doubt, a medical specialist should be consulted.
Between 18.5 and 24.9	The patient's weight is normal.
Between 25 and 30 (pre-obesity)	The patient is slightly to moderately overweight and should lose weight if already suffering from disease (e.g. diabetes, high blood pressure, gout, disorders of the fat metabolism).
Over 30	The patient urgently needs to lose weight as this is putting a strain on the metabolism, circulation and skeleton. The recommendation is for careful adherence to a diet, plenty of exercise and behavioural training. If in doubt, a medical specialist should be consulted.

Automatic switchover of weighing range

The scales are equipped with two weighing ranges. Weighing range 1 (→1←) offers a more precise weight indication with a reduced load-bearing capacity. Weighing range 2 (→2←) allows you to take advantage of the maximum load-bearing capacity of the scales.

When the scales are switched on, weighing range 1 is activated. If a specific weight value is exceeded, the scales automatically switch to weighing range 2.

To switch back to weighing range 1 proceed as follows:

- ▶ Remove all loads on the scales.
Weighing range 1 is activated again.

Switch off scales



- ▶ Press the Start key.

NOTE:

In rechargeable battery operation, the scale switches off after a short time if there is no load on it.

6.3 Additional functions (menu)

Additional functions are available in the menu for the scales. This allows you to configure the scales perfectly to your own needs.

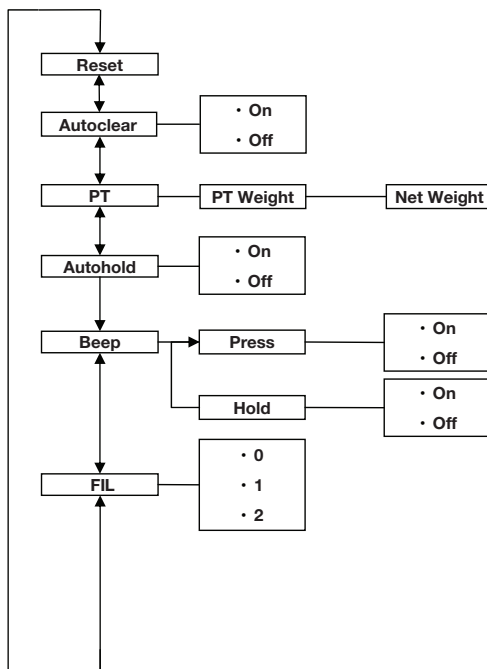

Navigate in the menu

1. Switch on the scales.
2. Hold down the arrow key (**bmi/menu**) until the menu is called up.



AHOLD

The last menu item selected is shown in the display (here: Autohold “AHOLD”).



FIL

3. Keep pressing one of the arrow keys until the required menu item appears in the display (here: attenuation “FIL”).



FIL 0

4. Confirm your selection with the Enter key.
The current selection for the menu item or a submenu is displayed (here level “0”).



5. To change your selection or call up another sub-menu, keep pressing one of the arrow keys until the required selection is displayed (here: level "2").
6. Confirm the selection with the Enter key. You will leave the menu automatically.
7. To make further selections, call up the menu again and proceed as described above.

NOTE:

If no key is pressed for approx. 24 seconds, you will leave the menu automatically.

Clear stored values automatically (ACLR)



To avoid storing obsolete measured results in the device memory and so calculating the BMI incorrectly, you can set the scales to ensure measured values are automatically cleared after 5 minutes.

NOTE:

With certain models this function is already activated at the factory. If required, you can disable this function.

1. Select the item "ACLR" in the menu.
2. Confirm the selection.
3. Select the setting you require:
 - On
 - Off
4. Confirm the selection. You will leave the menu automatically.

Permanently store additional weight (Pt)

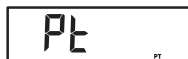

You can use the Pre-Tare function to permanently store an additional weight and automatically deduct it from the measured result. You can for example store a flat-rate figure as the weight of shoes and clothing and then always deduct it from the measured result when a patient is weighed fully dressed.

1. Select the item "Pt" in the menu. The message "Pt" appears.
2. Confirm your selection. Arrows can be seen flashing in the display. The additional weight last stored is displayed.
3. You can accept the stored value or adjust it using the arrow keys.

NOTE:

If you enter the value “0”, the function will be switched off. The message “Pt” will no longer be displayed.



7000 kg

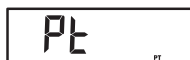

Pt

4. Confirm your selection.
5. Ask the patient to sit down on the scale.

The patient's weight is displayed.

The additional weight stored has been automatically deducted.

6. To disable this function, select the item “Pt” in the menu again.

7. Confirm your selection.

The function is disabled.

You will leave the menu automatically.

NOTE:

When you switch the scale off, the function is switched off. The message “Pt” is no longer displayed when you switch the scale on again.

Activate Autohold function (AHOLD)

If you activate the Autohold function, the measured result for each weighing operation will continue to be displayed after the load has been removed. This means you no longer have to manually activate the Hold function for every weighing operation.

NOTE:

With certain models this function is already activated at the factory. If required, you can disable this function.



AHOLD



On

1. Select the item “AHOLD” in the menu.

2. Confirm the selection.

The current selection is displayed.

3. Select the setting you require:

- On
- Off

4. Confirm your selection.

You will leave the menu automatically.

Activate acoustic signals (bEEP)

You can select whether an acoustic signal is to be emitted whenever a key is pressed or a stable weighing value has been attained. The latter is relevant for the Hold/Autohold function.

NOTE:

The function "Acoustic signal with stable weighing value" is activated at the factory. If required, you can disable this function.

bEEP

PrESS

On

1. Select the item "bEEP" in the menu.
2. Confirm the selection.
3. Select a menu item:
 - PrESS: Acoustic signal whenever a key is pressed
 - Hold: Acoustic signal with a stable weighing value.
4. Confirm your selection.
The current selection is displayed.
5. Select the setting you require:
 - On
 - Off
6. Confirm your selection.
You will leave the menu automatically.
7. If you also wish to activate the acoustic signal for the second function, repeat this procedure.

Select attenuation (FIL)

You can use attenuation (FIL = filter) to reduce any interference during weighing (e.g. caused by patient moving).

FIL

FIL 0

FIL 2

1. Select the item "FIL" in the menu.
2. Confirm the selection.
The current selection is displayed.
3. Select an attenuation level.
 - 0: no attenuation
 - 1: moderate attenuation
 - 2: high attenuation
4. Confirm the selection.
You will leave the menu automatically.

Restore factory settings (rESEt)

You can restore the factory settings for the following functions:

Function	Factory setting
Autohold (AHOLd)	Off
Acoustic signal (PrESS)	Off
Acoustic signal (Hold)	On
Attenuation (FIL)	0
Autoclear (Aclear)	On
Pre-Tare (Pt)	0 kg
Height for body mass index (BMI)	170 cm



1. Select the item "rESEt" in the menu.
2. Confirm the selection.
You will leave the menu automatically.
3. Switch the scales off.
The factory settings are restored and will be available when the scales are next switched on.

7. CLEANING

Clean the seat and frame on an as needed basis using a household cleaner or a commercial disinfectant. Follow the manufacturer's instructions.

Do not use scouring or caustic cleaning products, spirit, petrol or similar substances for cleaning under any circumstances. Such products may damage the high-quality finishes.

8. WHAT TO DO IF ...?

Malfunction	Cause/Remedy
... no weight is displayed during weighing?	The scale has no power supply. <ul style="list-style-type: none"> - Check whether the scale is switched on - Check whether the rechargeable battery block is inserted
... 0.00 does not appear before weighing?	A load was placed on the scales before being switched on. <ul style="list-style-type: none"> - Remove load - Switch scales off and back on again
... a segment lights up continuously or not at all?	There is a fault at that point. <ul style="list-style-type: none"> - Notify maintenance service.
...  is displayed?	The voltage of the rechargeable battery block drops. <ul style="list-style-type: none"> - Charge the rechargeable battery block as soon as possible
... bAtt is displayed?	Rechargeable battery block is empty. <ul style="list-style-type: none"> - Charge rechargeable battery block
... StOp is displayed?	The maximum load has been exceeded. <ul style="list-style-type: none"> - Reduce load
... TEMP is displayed?	The ambient temperature of the scales is too high or too low. <ul style="list-style-type: none"> - Set up scales in an ambient temperature between +10 °C and +40 °C - Wait approx. 15 minutes until scales have adjusted to ambient temperature
... Er:[No.]:11 is displayed?	The scales are too high, or too great a load is applied at one point. <ul style="list-style-type: none"> - Reduce load on scales or distribute weight more evenly - Restart scales
... Er:[No.]:12 is displayed?	The scales have been switched on with too great a load. <ul style="list-style-type: none"> - Reduce load on scales - Restart scales
... Er:[No.]:16 is displayed?	Oscillation of the scales has occurred, preventing determination of the zero point. <ul style="list-style-type: none"> - Restart scales

9. MAINTENANCE/VERIFICATION

9.1 Information about maintenance and verification

We recommend having maintenance performed prior to verification of the scales.

ATTENTION!

Incorrect measurement due to improper maintenance

- Make sure that maintenance and repair are only carried out by an authorised service partner.
- You can find your local service partner at www.seca.com or just send an e-mail to service@seca.com.

Ensure that verification is carried out by authorised persons in accordance with the national legal requirements.

Verification is required in all cases if one or more verification seals have been damaged or the content of the verification counter does not match the number on the valid verification counter sticker.

9.2 Check content of verification counter

These seca scales have been verified. Verification may only be performed by authorised bodies. To ensure this, the scales are equipped with a verification counter which registers every change in data relevant to calibration.



If you wish to check that the scales are properly verified, proceed as follows:



1. Switch the scales off if necessary.
2. Hold down any key and start up the scales.
The current content of the verification counter will flash in the display for a few seconds.
3. Compare the output content of the verification counter with the figure on the verification counter sticker.



The two figures must match for verification to be valid. If the sticker and verification counter do not match, verification is necessary. Contact your service partner or the seca customer service department. Once the scale has been verified, a new, updated verification sticker is used

to identify the verification counter state. This sticker is attached with an extra seal issued by the person authorized to perform the verification. The verification counter sticker can be ordered from seca customer service.

10. TECHNICAL DATA

Technical data for seca 955	
Dimensions <ul style="list-style-type: none"> • Depth • Width • Height 	956 mm 563 mm 897 mm
Weight	approx. 25 kg
Temperature range	+10° C to +40° C
Height of figures	25 mm
Power supply <ul style="list-style-type: none"> • Rechargeable battery block <ul style="list-style-type: none"> - Supply voltage 7.2 V • Power pack (model-dependent) <ul style="list-style-type: none"> - Supply voltage 12 V - Power consumption approx. 32 mA - Insulated device, protection class II (EN 60601-1)  	
Maximum runtime in rechargeable battery operation	approx. 2.400 minutes
Medical device according to directive 93/42/EEC	Class I with measuring function
Calibration according to directive 2014/31/EU	Class III
EN 60601-1: type B electromedical device	
Maximum load <ul style="list-style-type: none"> • Partial weighing range 1 • Partial weighing range 2 	150 kg 250 kg
Minimum load <ul style="list-style-type: none"> • Partial weighing range 1 • Partial weighing range 2 	1.0 kg 2.0 kg
Graduations <ul style="list-style-type: none"> • Partial weighing range 1 • Partial weighing range 2 	50 g 100 g
Tare range	250 kg

Technical data for seca 955	
Accuracy following initial calibration	
• Partial weighing range 1, 0 kg up to 25 kg	±25 g
• Partial weighing range 1, 25 kg up to 100 kg	±50 g
• Partial weighing range 1, 100 kg up to 150 kg	±75 g
• Partial weighing range 2, 0 kg up to 50 kg	±50 g
• Partial weighing range 2, 50 kg up to 200 kg	±100 g
• Partial weighing range 2, 200 kg up to 250 kg	±150 g

11. SPARE PARTS

Spare parts	Article number
Switch mode power pack: 100-240V~ / 50-60Hz / 12V= / 0.5A	68-32-10-266
Rechargeable battery block	68-22-12-721
Power pack carrier pouch seca 471	471-00-00-009

12. DISPOSAL

12.1 Disposal of device



Do not discard with household waste. The device must be disposed of properly as electronic waste. Comply with the national provisions applicable in your country. For further information contact our service department at:

service@seca.com

12.2 Batteries (including rechargeables)



Spent (rechargeable) batteries should not be discarded with household waste, regardless of whether they contain harmful substances or not. As a consumer you are obliged by law to dispose of (rechargeable) batteries via the collection points set up by the municipal authorities or the retail sector. Only discard (rechargeable) batteries when fully discharged.

13. WARRANTY

We offer a two-year warranty from the date of delivery for defects attributable to faulty material or poor workmanship. This excludes all moveable parts such as (rechargeable) batteries, cables, power supply units, etc. Defects which are covered by the warranty shall be rectified free of charge for customers on production of the sales receipt. No further claims can be accepted. The costs of shipment in both directions shall be borne by the customer where the device is not located at the customer's premises. In the event of any damage during shipment warranty claims can only be asserted where the complete original packaging was used for shipment and the scales were secured inside in the same manner as in the original packaging. You should therefore keep all packaging.

The warranty shall become null and void where the device is opened by persons not expressly authorised to do so by seca.

We ask customers based abroad to contact their local sales agent direct in the case of warranty claims.

14. DECLARATION OF CONFORMITY



seca gmbh & co. kg hereby declares that the product meets the terms of the applicable European directives. The unabridged declaration of conformity can be found at: www.seca.com.

Medguard Professional Healthcare

Tel: +353 (0) 1 835 2411

Email: sales@medguard.ie

Fax: 01 969 5009

Website: www.medguard.ie

Unit 6/7, Block 4, Ashbourne Business Park, Ashbourne, Co. Meath, A84 VK52