

# UM-201

## Digital Blood Pressure Monitor

### Instruction Manual



HPRA Wholesalers authorisation No. W00426/00001

Tel: +353 (0) 1 835 2411

Email: [sales@medguard.ie](mailto:sales@medguard.ie)

Unit 28B Ashbourne Business Centre, Ashbourne, Co Meath, A84 WA49

# Contents

Dear Customers.....	2
Preliminary Remarks .....	2
Precautions.....	2
Parts Identification.....	5
Symbols.....	6
Using The Monitor .....	7
Installing / Changing The Batteries .....	7
Connecting The Air Hose .....	7
Connecting The AC Adapter .....	8
Selecting the Correct Cuff Size .....	8
Applying The Arm Cuff .....	9
Notes for Accurate Measurement .....	9
Measurement.....	9
After Measurement .....	9
Measurements .....	10
Normal Measurement.....	10
Measurement With The Desired Systolic Pressure .....	11
Pressure Bar Indicator .....	11
What Is An Irregular Heartbeat .....	11
Troubleshooting .....	12
Maintenance .....	13
Technical Data.....	15

# Dear Customers

Congratulations on purchasing a state-of-the-art A&D blood pressure monitor, one of the most advanced monitors available today. This device is designed for ease of use and accuracy.

**We recommend that you read through this manual carefully before using the device for the first time.**

## Preliminary Remarks

- This device conforms to the European Directive 93/42 EEC for Medical Products. This is made evident by the **CE**<sub>0123</sub> mark of conformity. (0123: The reference number to the involved notified body)
- The device is designed for use on adults only, not newborns or infants.
- Environment for use: The device is for indoor use.
- This device is designed to measure blood pressure and pulse rate of people for diagnosis.

## Precautions

### Installation or storage location for the device

- Extremes in room temperature, humidity, direct sunlight, shock or dust should be avoided.
- Use or keep the device in a stable location where there is no slope, no vibration and no mechanical shock (including when shipping).
- Use or keep the device in a location where the chemicals, medicines or gases are not present.
- The device and cuff are not water resistant.
- Measurement may be distorted if the device is used close to televisions, microwave ovens, cellular telephones, X-ray or other devices with strong electrical fields.
- A strong shock to the device may result in mechanical error or possible injury due to debris.
- Avoid tightly folding the cuff or storing the hose tightly twisted for long periods, as such treatment may shorten the life of the components.

## Confirmation before use

- Confirm that the device is safe and secure for accurate operation.
- Operate the device using the provided specified AC adapter.
- Only the specified options and consumables are allowed for use with this device.
- When reusing the device, confirm that the device is clean.
- This device should be used at a doctor or medical worker only. The device is not designed to be operated by a patient to avoid accidents and ensure accurate results.

## Precautions during using the device

- When error display appears on the device or there are some doubts in the measurement values, confirm the patient's vital signs by using the palpation or auscultation method. Check that the air hose has not been bent or blocked.
- Should an error be displayed on the device or test subject, stop the device and take corrective actions to regain safety.
- Do not wrap the cuff on the arm with a wound. That may not only result in reopening the wound but could also cause an infection.
- Ensure that the position of the cuff is applied at the same level as the heart. (Otherwise, the blood pressure value results in an error.)
- Do not start to measure the blood pressure without wrapping the cuff around the arm. That may result in the cuff bursting or other damage.
- Use the device so that the air hose is not bent or blocked. Using the cuff while the air hose is kinked or bent may result in a peripheral circulatory failure due to a hemostasis in the arm, remaining the air in the cuff.
- Do not apply the excessive force to the AC adapter cable, such as lifting the device or pulling out the AC adapter, by holding the AC adapter cable.
- Do not pull out or do not connect the specified AC adapter with a wet hand. That may result in an electrical shock or getting a burn.
- To measure blood pressure, the arm must be squeezed by the cuff hard enough to cause some numbness and possibly a temporary red mark to the arm.
- Follow local instructions specified in the hospital when the cuff is used on several or infectious patients. Otherwise cross infection may result.
- If the patient has a very weak or irregular heartbeat, the device may have difficulty in determining the blood pressure.

## Note

- Do not modify the device.
- The patient should be relaxed and avoid moving or talking during measurement. Otherwise that may result in a measurement error.
- To ensure accurate measuring, we recommend measuring the blood pressure after being in a relaxed state for at least five minutes.

## Care for after use

- ❑ When the cuff is infected by blood or body fluid, it should be safely disposed of according to local instructions or protocol to avoid any potential spread of infectious disease.
- ❑ Clean the device and cuff with a dry, soft cloth or a cloth dampened with water and a neutral detergent. Never use benzene, thinner or other harsh chemical to clean the device. For full details please read page 14.
- ❑ When carrying out maintenance on the device, turn the power off and remove the power cable from the outlet to prevent a risk of electrical shock.
- ❑ Do not spray, do not pour or do not spill a liquid on the main body, accessories, connectors, buttons or outlet ports.
- ❑ Do not perform autoclave or gas sterilization (EOG, formaldehyde gas or high concentration ozone etc.) on the device as this could result in degradation.
- ❑ The user (Hospital, clinic etc.) should have the management responsibility for a use and maintenance for the medical electronic device. Be sure to perform the specified daily and maintenance inspection for safe use.

## Specified battery

- ❑ Used equipment, parts and battery are not treated as ordinary household waste, and must be disposed of according to the applicable local regulations.
- ❑ Remove the specified battery from the device, and keep it elsewhere if you are not going to use the device for a month or more.
- ❑ If the liquid leaked from the specified battery gets into an eye, avoid rubbing it and fully rinse it off using water, then immediately seek medical attention.
- ❑ Do not apply a pressure or mechanical shock to the specified battery. That may result in an expansion or explosion.

## Contraindications

- ❑ Do not use the device where flammable gases such as anesthetic gases are present. It may cause an explosion.
- ❑ Do not use the device in highly concentrated oxygen environments, such as a high-pressure oxygen chamber or an oxygen tent.
- ❑ Do not apply the cuff to an arm if another electrical medical device is already attached.
- ❑ Do not apply the cuff on an arm receiving an intravenous drip or blood transfusion.
- ❑ Confirm that there is no harm to the patient when the cuff is applied to the patient's arm and if the patient has had a mastectomy then avoid the adjacent arm.



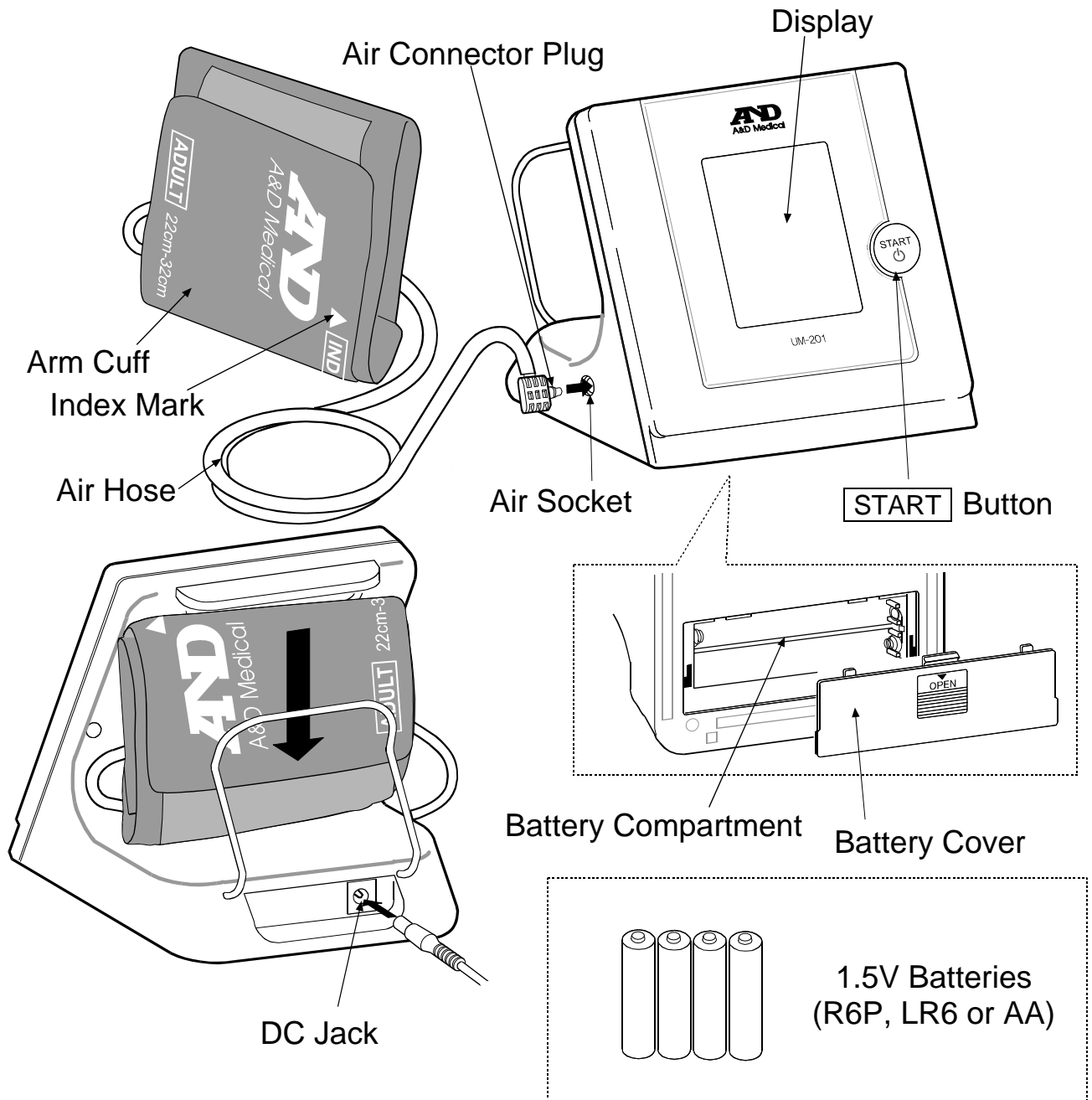



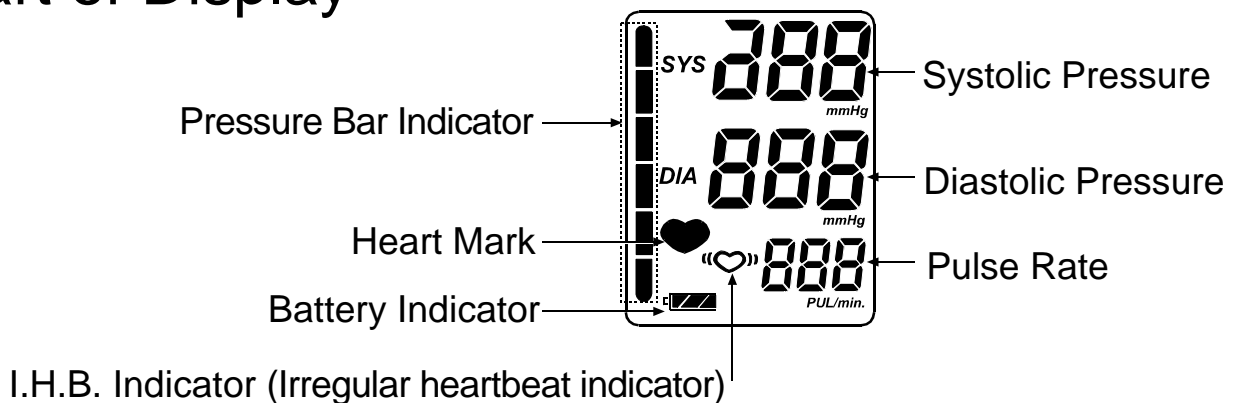



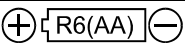



# Parts Identification





## Part of Display



# Symbols

Symbols	Function / Meaning	Recommended Action
	Standby and turn the device on.	_____
	Battery installation guide	_____
	Direct current	_____
SN	Serial number	_____
2015 	Date of manufacture	_____
	Type BF: Device, cuff and tubing are designed to provide special protection against electrical shocks.	_____
	The indicator that appears while measurement is in progress. It blinks when the pulse is detected.	Measurement is in progress. Remain as still as possible.
	<b>Irregular Heartbeat indicator. (I.H.B.)</b> The indicator that appears when an irregular heartbeat or any excessive body movement is detected during the measurement.	_____
	Full Battery The battery power indicator during measurement.	_____
	Low Battery The battery is low when it blinks.	Replace all batteries with new ones, when the indicator blinks.
Err	Unstable blood pressure due to movement during the measurement.	Try the measurement again. Remain very still during the measurement.  Fasten the cuff correctly, and try the measurement again.
	The systolic and diastolic values are within 10 mmHg of each other.	
	The pressure value did not increase during inflation.	
	The cuff is not fastened correctly.	
	PUL. DISPLAY ERROR The pulse is not detected correctly.	
SYS	Systolic blood pressure in mmHg	_____
DIA	Diastolic blood pressure in mmHg	_____
PUL./min.	Pulse per minute	_____
	EC directive medical device label	_____
	WEEE label	_____
	EU-representative	_____
	Manufacturer	_____

Symbols	Function / Meaning	Recommended Action
	Refer to instruction manual/booklet	_____
	Polarity of DC jack	_____



## Using The Monitor

### Installing / Changing The Batteries

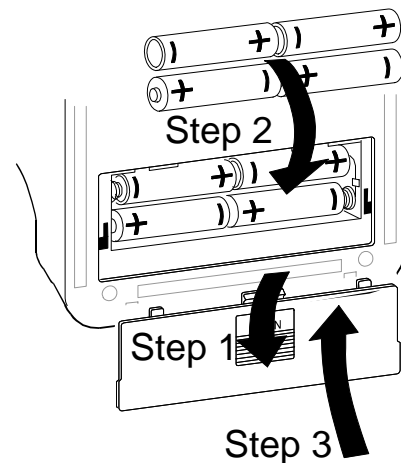
1. Slide the battery cover to open it.
2. Remove the used batteries and insert new batteries into the battery compartment as shown, taking care that the polarities (+) and (-) are correct.
3. Slide the battery cover to close it.  
Use only R6P, LR6 or AA batteries.



### CAUTION

- Insert the batteries as shown in the battery compartment. If not, the device will not work.
- When  (LOW BATTERY mark) blinks on the display, replace all batteries with new ones. Do not mix old and new batteries. It may shorten the battery life, or cause the device to malfunction.
-  (LOW BATTERY mark) does not appear when the batteries are drained.
- Battery life varies with the ambient temperature and may be shorter at low temperatures.
- Use the specified batteries only. The batteries provided with the device are for testing monitor performance and may have a limited life.
- Remove the batteries if the device is not to be used for a long time. The batteries may leak and cause a malfunction.

### Connecting The Air Hose

Insert the air connector plug into the air socket firmly.

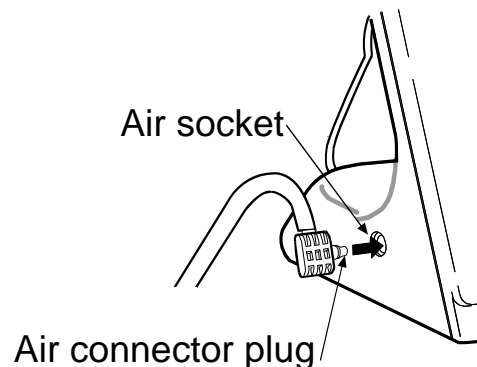



# Using The Monitor

## Connecting The AC Adapter

Insert the AC adapter plug into the DC jack. Next, connect the AC adapter to an electrical outlet.

The AC adapter, the model TB-233, is sold separately.

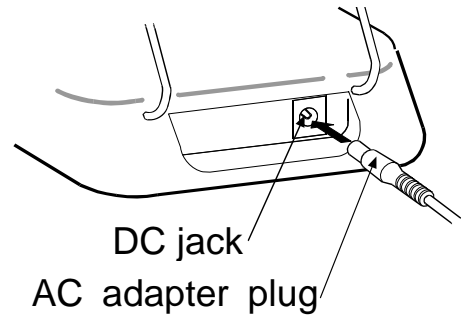

## Selecting the Correct Cuff Size

Using the correct cuff size is important for an accurate reading. If the cuff is not the proper size, the reading may yield an incorrect blood pressure value.

- The arm cuff is a consumable. If it becomes worn, purchase a new one.

Arm Size	Cuff Size	Symbols	Catalog No.
31 cm to 45 cm	LA Cuff	LARGE ADULT	CUF-KS-LA
22 cm to 32 cm	A Cuff	ADULT	CUF-KS-A
16 cm to 24 cm	SA Cuff	SMALL ADULT	CUF-KS-SA

Arm size: The circumference of the biceps.

## Symbols that are printed on the cuff

Symbols	Descriptions
REF	Means a code for when ordering the cuff to the manufacture.
▲ INDEX	INDEX symbol Means the symbol for showing that the cuff is wrapped in a proper fit range if this symbol is within the RANGE line.
ARTERY ▼	ARTERY symbol Place this symbol on the artery at the upper arm or thigh.
LATEX FREE	Means the symbol for showing that the latex is not included in this product.
CE	Means the symbol for showing the conformability mark.
LOT	Means the symbol for showing a lot number for when manufacturing. The lot number is printed by the carved seal around this mark.
RANGE	RANGE symbol The index symbol with the cuff should be in a range of this symbol.
!	Means the symbol for suggestions on operation
THIS SIDE TO PATIENT	Means the symbol for the patient side.

# Using The Monitor

## Applying The Arm Cuff

1. Face the palm of the left arm upward, and wrap the cuff around the upper arm, about 1-2 cm above the inside of the elbow. A range where the INDEX mark can be overlapped on the RANGE mark shows a proper fit range for the cuff.
2. Place the cuff on the upper arm so that the ▼ mark is overlapped on the artery.
3. Wrap while keeping the looseness with the cuff around the upper arm so that it allows the one or two fingers to insert between the cuff and arm.

Do not roll up shirtsleeve tightly

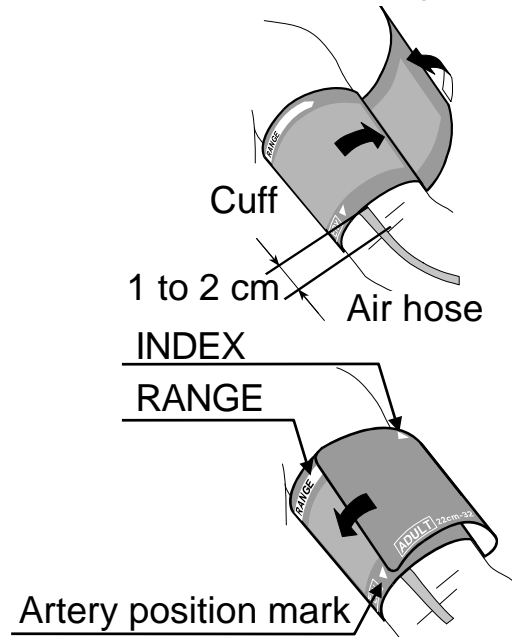

## Notes for Accurate Measurement

- ❑ Let a patient sit down in a comfortable position. Confirm that a patient does not cross the legs, patient's legs touch on the floor and patient's back and arms are supported. Let a patient place the arm on a table with the palm facing upward and the cuff at the same level as patient's heart.
- ❑ Let a patient relax for about five to ten minutes before taking a measurement. If a patient is excited or depressed by emotional stress, the measurement will reflect this stress as a higher (or lower) than normal blood pressure reading and the pulse reading will usually be faster than normal.

## Measurement

During measurement, it is normal for the cuff to feel very tight. (Do not be alarmed).

## After Measurement

After measurement, press the **START** button to turn off the power.  
Remove the cuff.

Note: The device has an automatic power shut-off function, which turns the power off automatically one minute after measurement.

# Measurements

Model UM-201 is designed to detect the pulse and to inflate the cuff to a systolic pressure level automatically.

If the patient's systolic pressure is expected to exceed 230 mmHg, read "Measurement With The Desired Systolic Pressure" on the next page.

## Normal Measurement

1. Place the cuff on the arm.  
Sit quietly during measurement.
2. Press the **START** button.  
All of the display segments are displayed. Then, 0 (zero) is displayed blinking briefly. Then the display changes, as indicated in the figure at the right, as the measurement begins. The cuff starts to inflate. It is normal for the cuff to feel very tight. A pressure bar indicator is displayed, as in the figure at the right, during inflation.

Note: If you wish to stop inflation at any time, press the **START** button again.

3. When inflation is complete, deflation starts automatically and ♥ (heart mark) blinks, indicating that the measurement is in progress. Once the pulse is detected, the mark blinks with each pulse beat.

Note: If an appropriate pressure is not obtained, the device starts to inflate again automatically.

4. When the measurement is complete, the systolic and diastolic pressure readings and pulse rate are displayed. The cuff exhausts the remaining air and deflates completely.
5. Press the **START** button again to turn off the power.

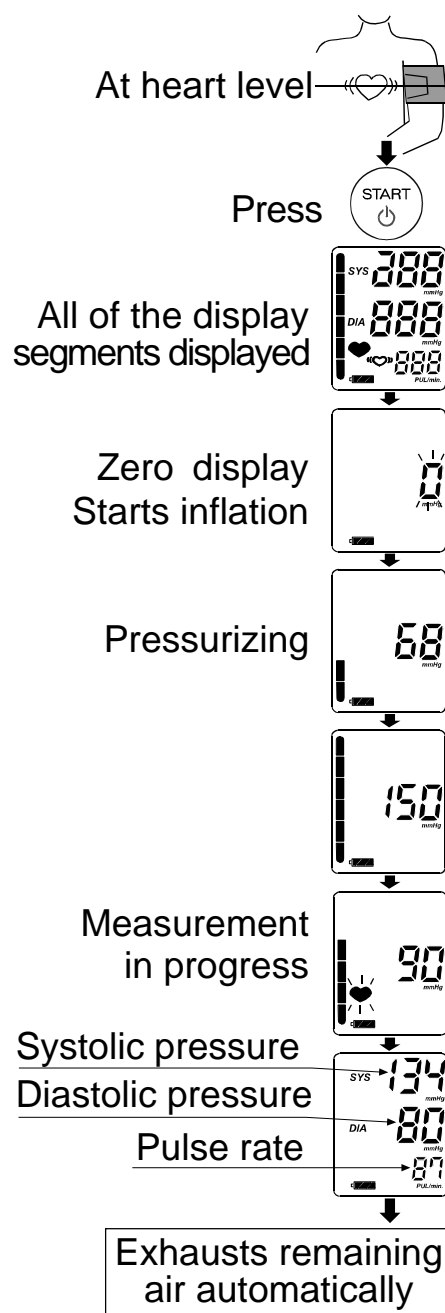

Note: The device has an automatic power shut-off function, which turns the power off automatically one minute after measurement.

# Measurements

## Measurement With The Desired Systolic Pressure

If the patient's systolic pressure is expected to exceed 230 mmHg, use this procedure.

1. Place the cuff on the arm.
2. Press and hold the **START** button until a number about 30 to 40 mmHg higher than the patient's expected systolic pressure appears.
3. Release the **START** button to start measurement, when the desired number is reached. Then continue to measure the patient's blood pressure as described on the previous page.

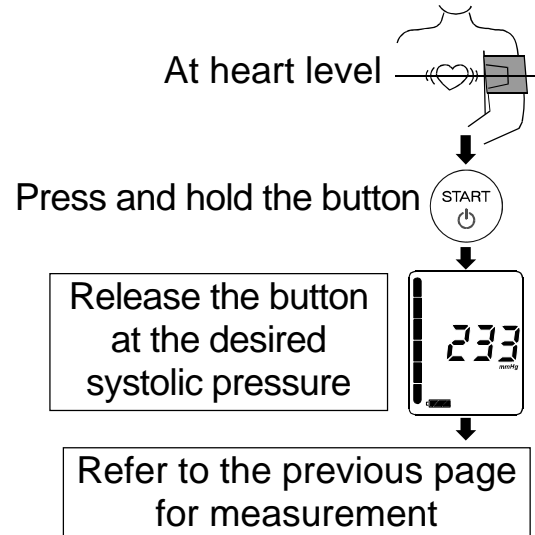

## Pressure Bar Indicator

The indicator monitors the progress of pressure during measurement.

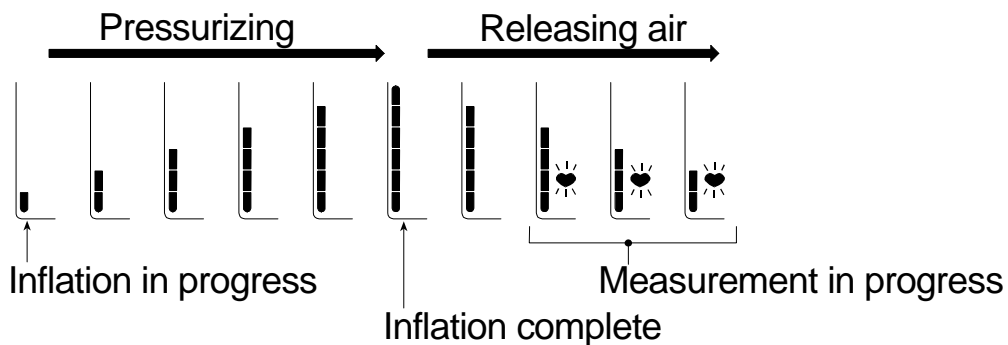

## What Is An Irregular Heartbeat

The UM-201 blood pressure monitor provides a blood pressure and pulse rate measurement even when an irregular heartbeat occurs. An irregular heartbeat is defined as a heartbeat that varies by 25% from the average of all heartbeats during the blood pressure measurement. It is important that the patient be relaxed, remain still and do not talk during measurements.

# Troubleshooting

Problem	Possible Reason	Recommended Action
Nothing appears on the display, even when the power is turned on.	Batteries are drained.	Replace all batteries with new ones.
	Battery terminals are not in the correct position.	Reinstall the batteries with negative and positive terminals matching those indicated on the battery compartment.
The cuff does not inflate.	Battery voltage is too low.  (LOW BATTERY mark) blinks. [ If the batteries are drained completely, the mark does not appear.]	Replace all batteries with new ones.
The unit does not measure. Readings are too high or too low.	The cuff is not fastened properly.	Fasten the cuff correctly.
	The cuff position is not correct.	Raise the patient's hand so that the cuff is at the same level as patient's heart.
	If the patient has a very weak or irregular heartbeat, the device may have difficulty in determining patient's blood pressure.	Measure the blood pressure by using the auscultation method.
Other	_____	Remove the batteries. Place them back properly and try the measurement again.

Note: If the actions described above do not solve the problem, contact the dealer. Do not attempt to open or repair this product, as any attempt to do so will make your warranty invalid.

# Maintenance

## Maintenance

Do not attempt to open the device as the delicate electrical components and intricate air unit inside could be damaged. If you cannot solve the problem using our troubleshooting guide, request assistance from your authorized dealer or from any A&D servicegroup.

The device was designed and manufactured for a long service life. However it is generally recommended to have the device inspected every 2 years, to ensure proper functioning and accuracy. Please contact either your authorized dealer or A & D for maintenance.

### Pressure confirmation

- Example of connection

- (1) Calibrated pressure gauge
- (2) UM-201
- (3) Tank : 500ml
- (4) Pressure generating device

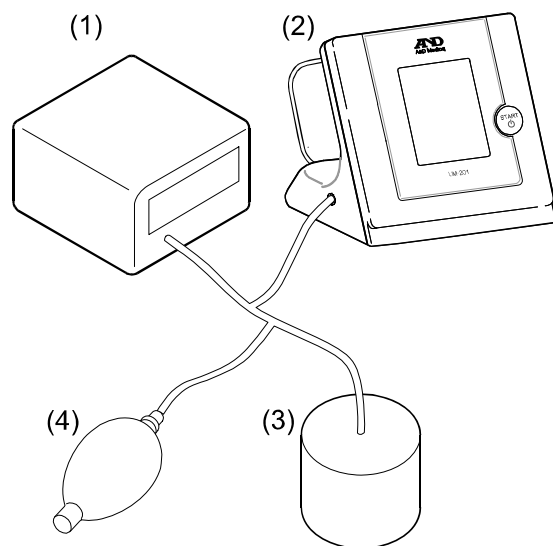

1. Remove the batteries from the battery compartment.
2. Press and hold the **START** button, and insert the batteries into the battery compartment, and proceed to pressure confirmation mode, the display at the UM-201 became  .
3. Add the pressure using the pressure generating device, and confirm the pressure at the pressure gauge and UM-201.

## Cleaning

- ❑ Remove the AC adapter from the device when cleaning the device.
- ❑ When the main body or cuff is dirty, wipe them fully by using a gauze or cloth dampened with warm water and a neutral detergent avoiding excess water.
- ❑ Do not use the moisten cloth etc. to wipe the DC jack and air socket. The DC jack and air socket must remain dry.
- ❑ To prevent a risk due to infection, disinfect the main body and cuff regularly. When disinfecting them, wipe them gently by using the gauze or dampened cloth with local antiseptic solution then wipe the moisture off the surface by using a dry soft cloth.  
Use a water solution using the dilution ratio described in the instructions for this product. The following shows the example in which can be used as antiseptic solution (Ingredient name).  
- Chlorhexidine gluconate / Benzalkonium chloride
- ❑ Clean the device about once every month, basing on a policy or instruction specified in the hospital or clinic.













## CAUTION

- ❑ The blood pressure monitor is not waterproof device. Do not splash water on it and avoid exposure to moisture.
- ❑ Do not use a organic solvent such as thinner or benzine.
- ❑ The blood pressure monitor can not be sterilized by autoclave, EOG or formaldehyde etc.

## Regular inspection

- ❑ The blood pressure monitor is a precision device. Therefore, inspect it regularly. Request an inspection to the dealer where you have purchased the device when the device is in needs of an inspection,
- ❑ The cuff is consumable. Regularly exchange the cuff with new one.

# Technical Data

Type	UM-201
Measurement method	Oscillometric measurement
Measurement range	Pressure: 0 - 299 mmHg Pulse: 40 - 180 beats / minute
Measurement accuracy	Pressure: $\pm 3$ mmHg Pulse: $\pm 5$ %
Power supply	4 x 1.5V batteries (R6P, LR6 or AA) or AC adapter (TB-233) (Not included)
Number of measurements	Approx. 450 measurements, when AA Alkaline batteries are used, with pressure value of 180 mmHg at room temperature of 23°C
Classification	Internally powered ME equipment (Supplied by batteries) Class II (Supplied by adapter) Continuous operation mode
Clinical test	According to ANSI / AAMI SP-10 1992
EMC	IEC 60601-1-2: 2007
Operating conditions	+10°C to +40°C / 15 %RH to 85 %RH 800 hPa to 1060 hPa
Transport / Storage conditions	-10°C to +60°C / 15 %RH to 85 %RH
Dimensions	Approx. 150 [W] x 156 [H] x 120 [D] mm
Weight	Approx. 480 g, excluding the batteries
Applied part	Cuff Type BF 
Useful life	Device: 5 years (when used six times a day) Cuff: 2 years (when used six times a day)
Accessory AC adapter	The adapter is to connect the blood pressure monitor to a power source at home.
TB-233	Please contact your local A&D dealer for purchasing. The AC adapter is required to be inspected or replaced periodically.
TB-233C	Input: 100-240V Output: 6V  500mA     139°C  2A
TB-233BF	Input: 100-240V Output: 6V  500mA     139°C  2A



Accessories sold separately

Cuff

Arm Size	Cuff Size	Catalog Number
31 cm to 45 cm	LA Cuff	CUF-KS-LA
22 cm to 32 cm	A Cuff	CUF-KS-A
16 cm to 24 cm	SA Cuff	CUF-KS-SA

AC adapter

Plug	Catalog Number
Type C	TB-233C
Type BF	TB-233BF

Note: Specifications are subject to change without prior notice.

Medical Electrical Equipment needs special precautions regarding EMC and needs to be installed and put into service according to the EMC information provided in the following. Portable and mobile RF communication equipment (e.g. cell phones) can affect Medical Electrical Equipment.

The use of accessories and cables other than those specified may result in increased emissions or decreased immunity of the unit.

<b>Guidance and manufacturer's declaration – electromagnetic emissions</b>		
The UM-201 is intended for use in the electromagnetic environment specified below. The customer or the user of the UM-201 should assure that it is used in such an environment.		
<b>Emissions test</b>	<b>Compliance</b>	<b>Electromagnetic environment – guidance</b>
RF emissions CISPR 11	Group 1	The UM-201 uses RF energy only for its internal function. Therefore, its RF emissions are very low and are not likely to cause any interference in nearby electronic equipment.
RF emissions CISPR 11	Class B	The UM-201 is suitable for use in all establishments, including domestic establishments and those directly connected to the public low-voltage power supply network that supplies buildings used for domestic purposes.
Harmonic emissions IEC 61000-3-2	Class A	
Voltage fluctuations / flicker emissions IEC 61000-3-3	Complies	

<b>Recommended separation distances between portable and mobile RF communications equipment and the UM-201</b>			
The UM-201 is intended for use in an electromagnetic environment in which radiated RF disturbances are controlled. The customer or the user of the UM-201 can help prevent electromagnetic interference by maintaining a minimum distance between portable and mobile RF communications equipment (transmitters) and the UM-201 as recommended below, according to the maximum output power of the communications equipment.			
<b>Rated maximum output power of transmitter</b>  W	<b>Separation distance according to frequency of transmitter</b> m		
	<b>150 kHz to 80 MHz</b> $d = 1.2 \sqrt{P}$	<b>80 MHz to 800 MHz</b> $d = 1.2 \sqrt{P}$	<b>800 MHz to 2.5 GHz</b> $d = 2.3 \sqrt{P}$
0.01	0.12	0.12	0.23
0.1	0.38	0.38	0.73
1	1.2	1.2	2.3
10	3.8	3.8	7.3
100	12	12	23
For transmitters rated at a maximum output power not listed above, the recommended separation distance $d$ in metres (m) can be estimated using the equation applicable to the frequency of the transmitter, where $p$ is the maximum output power rating of the transmitter in watts (W) according to the transmitter manufacturer.			
NOTE 1 At 80 MHz and 800 MHz, the separation distance for the higher frequency range applies.			
NOTE 2 These guidelines may not apply in all situations. Electromagnetic propagation is affected by absorption and reflection from structures, objects and people.			

**Guidance and manufacturer's declaration – electromagnetic immunity**

The UM-201 is intended for use in the electromagnetic environment specified below. The customer or the user of the UM-201 should assure that it is used in such an environment.

Immunity test	IEC 60601 test level	Compliance level	Electromagnetic environment – guidance
<p>Conducted RF IEC 61000-4-6</p> <p>Radiated RF IEC 61000-4-3</p>	<p>3 V<sub>rms</sub> 150 kHz to 80 MHz</p> <p>3 V/m 80 MHz to 2.5 GHz</p>	<p>3 V<sub>rms</sub></p> <p>3 V/m</p>	<p>Portable and mobile RF communications equipment should be used no closer to any part of the UM-201, including cables, than the recommended separation distance calculated from the equation applicable to the frequency of the transmitter.</p> <p><b>Recommended separation distance:</b></p> $d = 1.2 \sqrt{P}$ <p><math>d = 1.2 \sqrt{P}</math>    80 MHz to 800 MHz</p> <p><math>d = 2.3 \sqrt{P}</math>    800 MHz to 2.5 GHz</p> <p>where <i>P</i> is the maximum output power rating of the transmitter in watts (W) according to the transmitter manufacturer and <i>d</i> is the recommended separation distance in metres (m).</p> <p>Field strengths from fixed RF transmitters, as determined by an electromagnetic site survey,<sup>a</sup> should be less than the compliance level in each frequency range.<sup>b</sup></p> <p>Interference may occur in the vicinity of equipment marked with the following symbol: </p>

NOTE 1 At 80 MHz and 800 MHz, the higher frequency range applies.

NOTE 2 These guidelines may not apply in all situations. Electromagnetic propagation is affected by absorption and reflection from structures, objects and people.

<sup>a</sup> Field strengths from fixed transmitters, such as base stations for radio (cellular/cordless) telephones and land mobile radios, amateur radio, AM and FM radio broadcast and TV broadcast cannot be predicted theoretically with accuracy. To assess the electromagnetic environment due to fixed RF transmitters, an electromagnetic site survey should be considered. If the measured field strength in the location in which the UM-201 is used exceeds the applicable RF compliance level above, the UM-201 should be observed to verify normal operation. If abnormal performance is observed, additional measures may be necessary, such as re-orienting or relocating the UM-201.

<sup>b</sup> Over the frequency range 150 kHz to 80 MHz, field strengths should be less than 3 V/m.

### Guidance and manufacturer's declaration – electromagnetic immunity

The UM-201 is intended for use in the electromagnetic environment specified below. The customer or the user of the UM-201 should assure that it is used in such an environment.

Immunity test	IEC 60601 test level	Compliance level	Electromagnetic environment – guidance
Electrostatic discharge (ESD) IEC 61000-4-2	± 6 kV contact  ± 8 kV air	± 6 kV contact  ± 8 kV air	Floors should be wood, concrete or ceramic tile. If floors are covered with synthetic material, the relative humidity should be at least 30%.
Electrical fast transient / burst IEC 61000-4-4	± 2 kV for power supply lines  ± 1 kV for input/output lines	± 2 kV for power supply lines  ± 1 kV for input/output lines	Mains power quality should be that of a typical commercial or hospital environment.
Surge IEC 61000-4-5	± 1 kV line to line  ±2 kV line to earth	± 1 kV line to line  ±2 kV line to earth	Mains power quality should be that of a typical commercial or hospital environment.
Voltage dips, short interruptions and voltage variations on power supply input lines IEC 61000-4-11	< 5% $U_T$ (> 95% dip in $U_T$ ) for 0.5 cycle  40% $U_T$ (60% dip in $U_T$ ) for 5 cycles  70% $U_T$ (30% dip in $U_T$ ) for 25 cycles  < 5% $U_T$ (> 95% dip in $U_T$ ) for 5 s	< 5% $U_T$ (> 95% dip in $U_T$ ) for 0.5 cycle  40% $U_T$ (60% dip in $U_T$ ) for 5 cycles  70% $U_T$ (30% dip in $U_T$ ) for 25 cycles  < 5% $U_T$ (> 95% dip in $U_T$ ) for 5 s	Mains power quality should be that of a typical commercial or hospital environment. If the user of the UM-201 requires continued operation during power mains interruptions, it is recommended that the UM-201 be powered from an uninterruptible power supply or a battery.
Power frequency (50 / 60 Hz) magnetic field IEC 61000-4-8	3 A/m	3 A/m	Power frequency magnetic fields should be at levels characteristic of a typical location in a typical commercial or hospital environment.

NOTE :  $U_T$  is the AC mains voltage prior to application of the test level.

HPRA Wholesalers authorisation No. W00426/00001

Tel: +353 (0) 1 835 2411

Email: [sales@medguard.ie](mailto:sales@medguard.ie)

Unit 28B Ashbourne Business Centre, Ashbourne, Co Meath, A84 WA49